

USER MANUAL

BOILER CONTROLLER

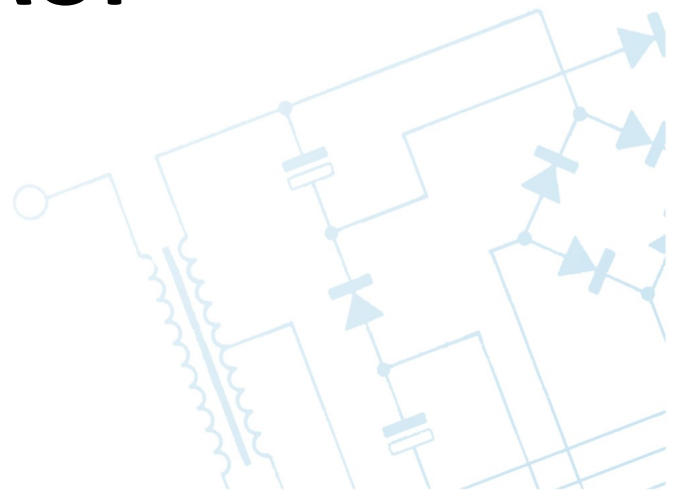

IGNEO COMPACT





Index

1 General information	5
1.1 Introduction	5
1.2 Features	5
1.3 Safety precautions	7
1.4 Disposal of old equipment	8
2 Connecting to the system	9
2.1 General requirements	9
2.2 Location	9
2.3 Assembly	10
2.4 Connecting	11
2.4.1 Direct connection of devices.....	11
2.4.2 Connecting using burner wire.....	13
3 Overview of the basic functions	15
3.1 Control panel	15
3.1.1 The status LED.....	15
3.1.2 Buttons.....	16
3.1.3 Graphic display	17
3.2 Statuses of furnace	17
4 Handling	18
4.1 Navigation in the menu	18
4.2 Starting regulator - ON	18
4.3 Switching off the regulator - OFF	18
4.4 Time scheduling	19
4.5 Service password	20
5 Simple menu	21
5.1 Simple menu screens	21
6 Main menu	23
6.1 Heating	24
6.1.1 Selection of circuit.....	24
6.1.2 State.....	24
6.1.3 Settings.....	25
6.1.4 Time program.....	25
6.1.5 Service.....	26
6.2 Hot water	28

Index

6.2.1 Selection of circuit.....	28
6.2.2 State.....	28
6.2.3 Settings.....	29
6.2.4 Time program.....	29
6.2.5 Service.....	30
6.3 Buffer	31
6.3.1 State.....	31
6.3.2 Settings.....	31
6.3.3 Time program.....	32
6.3.4 Service.....	32
6.4 Boiler	33
6.4.1 State.....	33
6.4.2 Settings.....	33
6.4.3 Service.....	34
6.5 Settings	35
6.5.1 Date and time.....	35
6.5.2 Language.....	35
6.5.3 General settings.....	35
6.5.4 Service.....	35
6.6 Burner	38
6.6.1 State.....	38
6.6.2 Settings.....	38
6.6.3 Service.....	39
6.7 Alarms	40
6.7.1 Alarm codes.....	40
6.8 Solar	46
6.8.1 State.....	46
6.8.2 Settings.....	46
6.8.3 Service.....	47
6.9 Info	47
7 Expansion of the system - CAN bus	48
7.1 Sonda Lambda	51
7.2 Solars	53
8 Specification	55

1 General information

Thank you for choosing our product and congratulations on a good decision. We will be grateful for comments concerning the unit's performance.

*ESTYMA electronics
Team*

1.1 Introduction

Controller IGNEO Compact is a modern microprocessor system, which controls not only the boiler, but also the central heating system and domestic hot water.

The device controls the burning process by providing the appropriate amount of air and fuel. By using solid state relays the power of blower is regulated smoothly.

Thanks to the advanced algorithm and possibility to regulation of many parameters, the system can be very flexible to adapt to the needs of the heating system.

1.2 Features

Graphic display – thanks to a large graphic display FSTN handling device is intuitive.

Large fonts and icon - to improve ease of handling equipment for elderly people.

Two types of menus - menus simple and sophisticated. During the daily operation of the device can support is easily accessible from the simple menu.

Info button - the controller is equipped with the function of intelligent assistance. Each parameter is described, calling the description is done by pushing the info button.

1 General information

The modular construction of the CAN - using industrial CAN bus data exchange (mainly used in the demanding automotive industry), it is possible to expansion of the system. The maximum extension is 16 heating circuits, two circuits of hot water, energy buffers and solars.

Buffer - controlling the heating system in combination with heat storage reservoir.

Solars - the controller controls the solar system.

Powerful modern 32-bit ARM processor (ARM family is widely used in mobile phones) - enables advanced controlling algorithm device Fuzzy Logic II generation.

The history of alarms and errors - the controller keeps a history of the last 20 errors and alarms with a description, date of creation and the date of confirmation.

Clock with calendar - the clock allows to program in a weekly cycle required temperatures in the rooms and hot water which contributes to a reduction in expenditure on fuel.

Statistics - in memory controller stores statistical data of the system, so it is possible to observe the work and reduce fuel consumption. For example, monitoring temperature and power boiler burner. Feeder operating time of the fuel.

Beep sound alarm - built-in piezoelectric loudspeaker signals the occurrence of an alarm in the boiler, which increases operational safety of the device.

Resetting - function allows you to restore factory settings of the controller.

1.3 Safety precautions

Warning – risk of electric shock!

- Read this operation manual carefully and thoroughly before using the unit.
- Keep this operation manual and refer to it whenever you work with this unit in the future.
- Apply all the rules and heed all the warnings included in the unit operation manual.
- Make sure that the unit is not damaged. In case of any doubts, do not use the unit and contact the supplier.
- In case of any doubts concerning the safe operation of the unit, contact the supplier.
- Pay special attention to all warning signs on the unit casing and its package.
- Use the unit as intended.
- The unit is not a toy. Do not allow children to play with it.
- Under no circumstances children should be allowed to play with any parts of the package of the unit.
- Access to small parts such as clamping screws or bolts should be secured against children. Such elements may be delivered with the unit and may result in choking when swallowed by a child.
- Do not make any mechanical or electrical changes to the unit. Such changes may cause the unit to malfunction and fail to meet the relevant standards, leading to an adverse impact on the performance of the unit.
- Do not insert any objects into the unit through openings (e.g. ventilation grills), as this may cause short circuiting, electric shock, fire or damage to the unit.
- Do not allow water, humidity or dust to enter the unit, as this may cause short circuiting, electric shock, fire or damage to the unit.
- Provide adequate ventilation of the unit, do not cover or block the ventilation grills, and ensure that there is free flow of air around the unit.
- The unit should be installed indoors unless it is adapted for outdoor operation.
- Do not expose the unit to mechanical impacts and vibrations.
- When connecting the unit to power supply, make sure that the parameters of the supply network are within the unit's operating range.
- All electrical connections must be as shown in the electrical assembly drawings and must comply with national and/or local regulations concerning electrical connections.

1 General information

- This unit contains no parts that may be replaced by the user. All maintenance work except for cleaning, fuse replacement (when the unit is de-energized), and function setting, should be performed by an authorized service provider.
- Before doing any maintenance work, you must cut off the power supply to the unit.
- Do not clean the casing of the unit with petrol, solvents or any other chemicals that may damage the casing of the unit. Using a soft cloth is recommended.

1.4 Disposal of old equipment

This electronic equipment is made of materials which are partly recyclable. Therefore, when the equipment has reached the end of its service life, take it to an electrical and electronic equipment recycling centre or to the manufacturer. The equipment must not be disposed of with other household waste.



2 Connecting to the system

2 Connecting to the system

2.1 General requirements

Read this operation manual carefully and thoroughly before you start using the unit.

The person installing the unit should have sufficient technical experience.

Copper wire connections should be designed to work in temperatures of up to +75°C .

All connections made must be as shown in the electrical wiring assembly drawings and must be compliant with national and/or local regulations concerning electrical connections.



WARNING !!! *The device must be connected to a separate electrical circuit equipped with an appropriately sized circuit breaker and residual current circuit breaker.*

2.2 Location

The unit is intended for indoor installation only. After selecting the location, make sure that it meets the following requirements:

1. The location must be free from excessive humidity and from flammable or corrosive vapours.

2. The unit must not be installed near high power electrical equipment, electrical machines or welding equipment.

3. The temperature in the location must not exceed 60°C and should not be lower than 0°C. Humidity should be within the range from 5% to 95%, with no vapour condensation taking place.

2 Connecting to the system

2.3 Assembly

The controller is designed for mounting in a wall or plate mounting. Plate thickness should not exceed 3mm. The minimum depth of the mounting hole is 100mm. The dimensions of the hole and controller are indicated in the figure below.

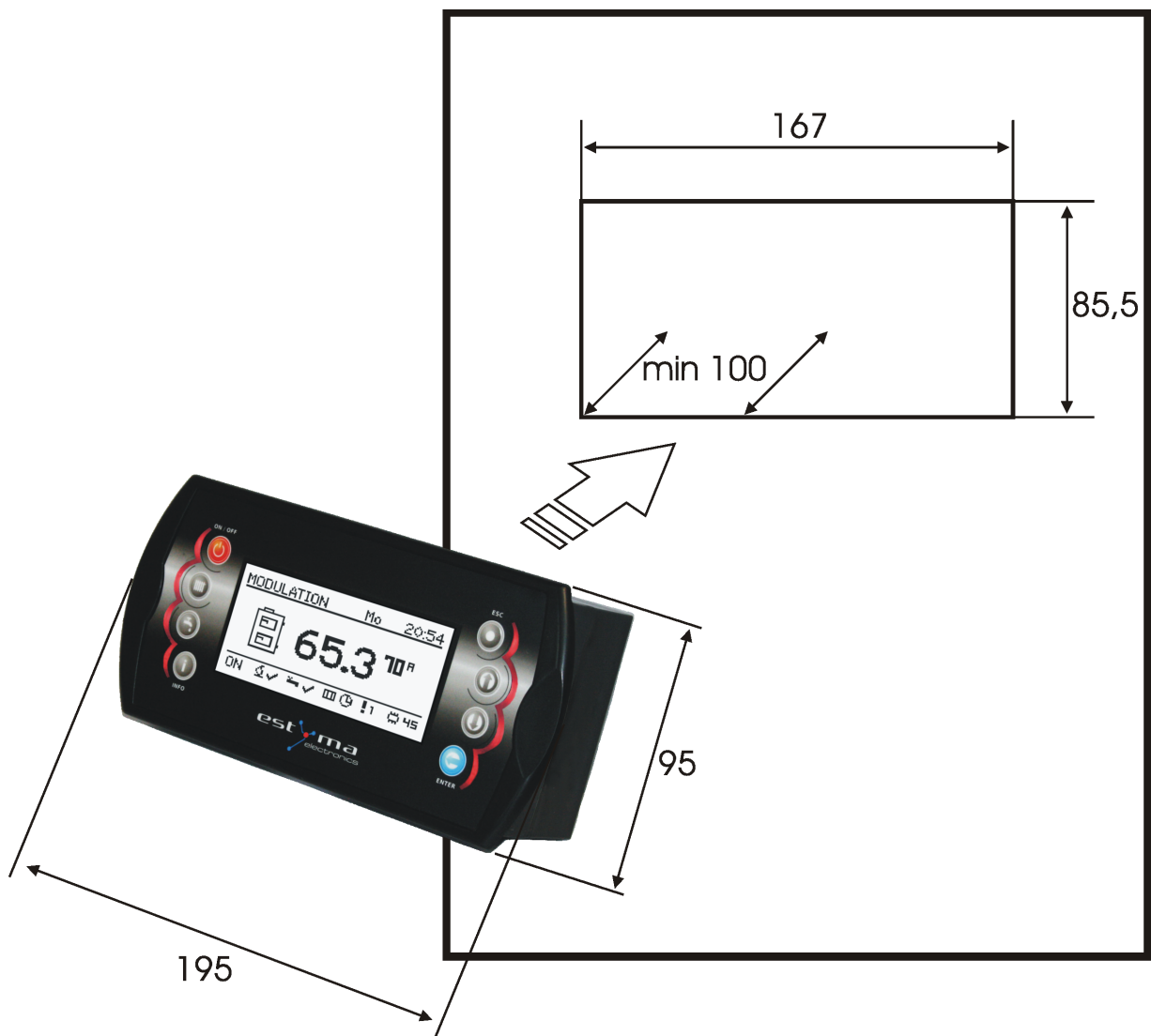

After placing the panel in the hole, always install the mounting frame.

2 Connecting to the system

2.4 Connecting

The device supply voltage is ~ 230V/50Hz. Plug the power cord to the controller in accordance with the posted signs.

Be attached to the controller for operating the boiler sensors and actuators as needed. The drawings shows the connection scheme of equipment. In the tables, a description of the inputs and outputs.

 **Warning !!!** Under no circumstances connect the protective conductor (PE) with a neutral (N).

 **Warning !!!** Wiring must be done with the device disconnected from the mains. Connections should be exercised by a person possessing adequate powers in this regard.

2.4.1 Direct connection of devices

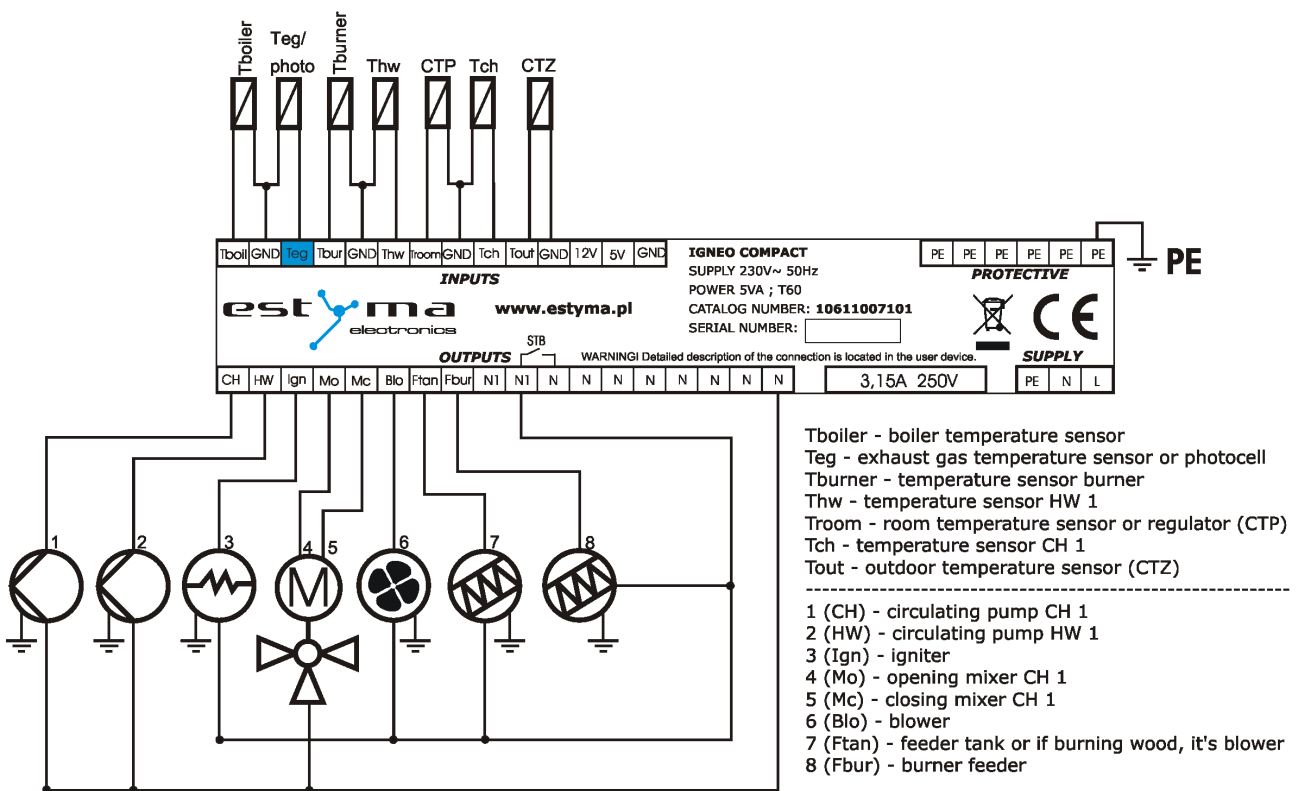

2 Connecting to the system

INPUTS	
Description	Explanation
Tboiler	Boiler temperature sensor
Teg / photo	Exhaust gas temperature sensor or photocell
Tburner	The temperature sensor burner
Thw	The temperature sensor hot water
Troom	Room temperature sensor / regulator (CTP)
Tch	The temperature sensor central heating
Tout	Outdoor temperature sensor (CTZ)
12V	+12V output to supply optional equipment
5V	+5V output to supply optional equipment
GND	Mass electric to connect sensors

OUTPUTS	
Description	Explanation
1 (CH)	Central heating circulating pump
2 (HW)	Circulating pump for hot water
3 (Ign)	Burner igniter
4 (Mo)	Opening the central heating mixer
5 (Mc)	Closing the central heating mixer
6 (Blo)	Burner blower
7 (Ftan)	Feeder tank, or if burning wood, it's blower
8 (Fbur)	Burner feeder
STB	Protection STB
N	Neutral standing
N1	Neutral separable such as by STB
PE	Protective

2 Connecting to the system

2.4.2 Connecting using burner wire

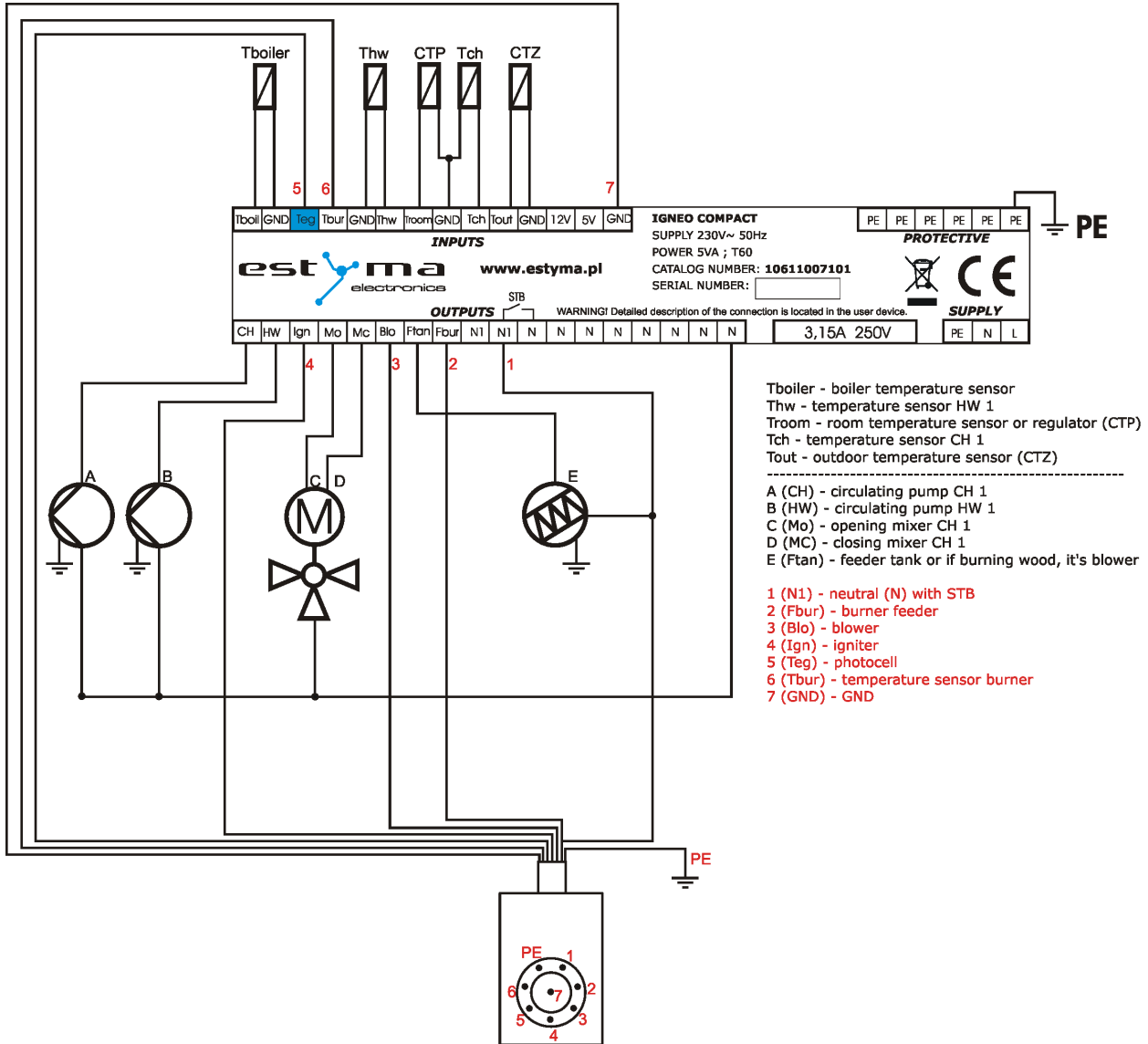

2 Connecting to the system

INPUTS	
Description	Explanation
Tboiler	Boiler temperature sensor
5 (Teg)	Photocell
6 (Tbur)	The temperature sensor burner
Thw	The temperature sensor hot water
Troom	Room temperature sensor / regulator (CTP)
Tch	The temperature sensor central heating
Tout	Outdoor temperature sensor (CTZ)
12V	+12V output to supply optional equipment
5V	+5V output to supply optional equipment
7 (GND)	Mass electric to connect sensors

OUTPUTS	
Description	Explanation
A (CH)	Central heating circulating pump
B (HW)	Circulating pump for hot water
4 (Ign)	Burner igniter
C (Mo)	Opening the central heating mixer
D (Mc)	Closing the central heating mixer
3 (Blo)	Burner blower
E (Ftan)	Feeder tank, or if burning wood, it's blower
2 (Fbur)	Burner feeder
1 (N1)	Neutral separable such as by STB
STB	Protection STB
N	Neutral standing
PE	Protective

3 Overview of the basic functions

3 Overview of the basic functions

3.1 Control panel

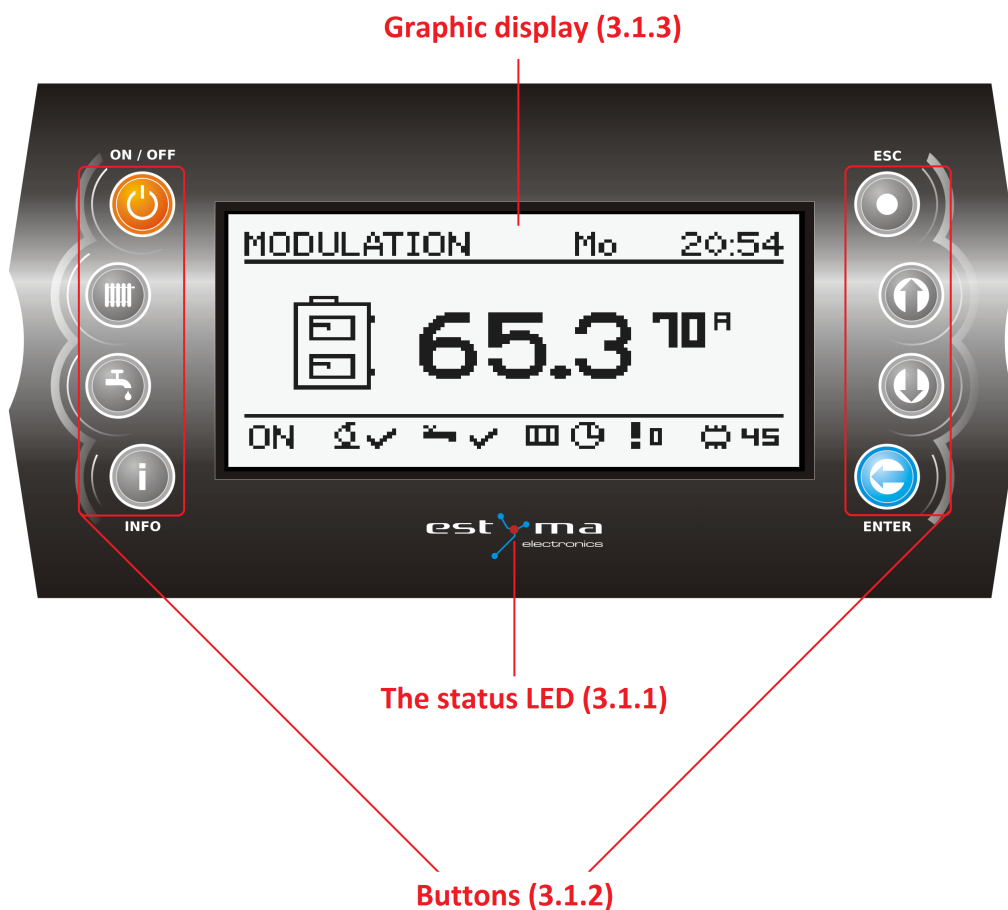









3.1.1 The status LED

Status	Importance
Green light continuously	Controller OFF
Green blinks	Controller enabled, burner OFF
Orange light continuously	Controller enabled, burner enabled
Orange blinks	Burner works
Red light continuously	There is an alarm to be confirmed
Red blinks	Alarm active

3 Overview of the basic functions

3.1.2 Buttons

Button	Function
 ON / OFF	Long press on the main screen (>3 seconds) changes the state of the ON/OFF (on/off).
 CH	Quick access to the full configuration settings for the central heating.
 HW	Quick access to the full configuration settings for hot water.
 INFO	Shows the navigation information and descriptions of the regulated parameters.
 ESC	Back one level up in the menu, the resignation of the parameter change.
 Up arrow	<p>Navigating through the menus, increasing the value of the parameter being edited.</p> <p>On main screen, enter the menu simple.</p>
 Down arrow	<p>Navigating through the menus, reducing the value of the parameter being edited.</p> <p>On main screen, enter the menu simple.</p>
 ENTER	<p>Access to the menu.</p> <p>Acceptance of changes in the value of the parameter being edited.</p> <p>Confirmation of the alarm.</p>

3 Overview of the basic functions

3.1.3 Graphic display

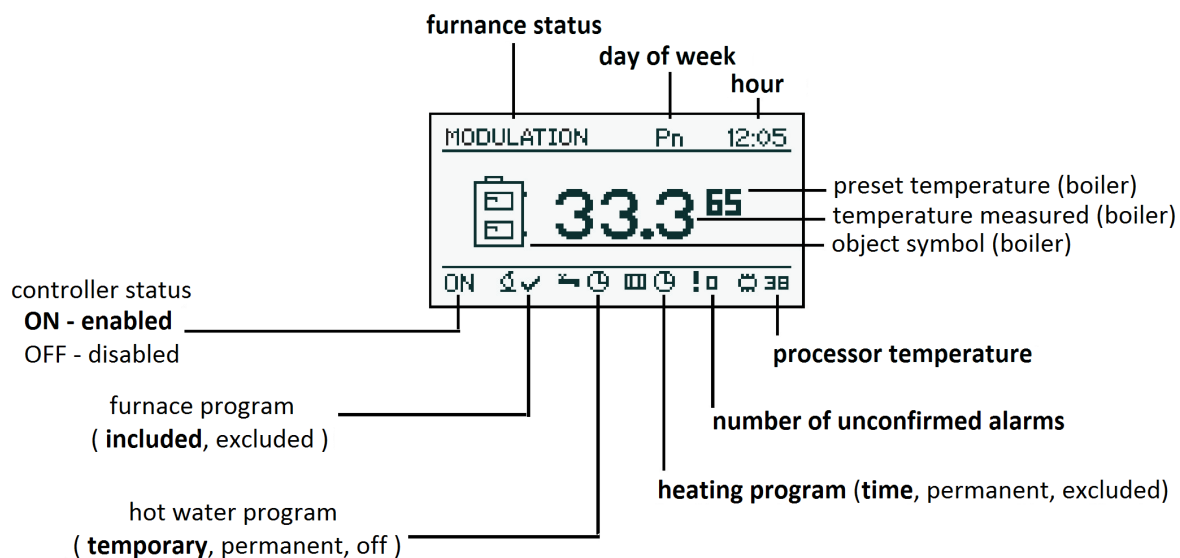

3.2 Statuses of furnace

Status	Description
TURNED OFF	The burner is not working. Permission to work off.
CLEANING	Cleaning the burner by strong stream of air.
FIRING UP	Firing up fuel. Providing the initial dose of fuel to run igniter and blower.
INCANDESCING	When the flame in phase of the firing up is discovered, starts providing additional portions of fuel and increase the power of blower for arcing furnace.
POWER 1	The burner works with the power first.
POWER 2	The burner works with the power of a second.
MODULATION	The burner works with a modulated power.
BURNING OFF	Quenching of the furnace. Work of burner and blower tray until the complete disappearance of the flame.
STOP	Burner does not work but it is to agree to his work. The required boiler temperature is reached.

4 Handling

4 Handling

4.1 Navigation in the menu

The device has two types of menus: simple and main menus.

Simple menu - allows for quick access to basic controller functions. Enter the menu is simple by pressing the "up arrow" or "down arrow" on the main screen. Description of a simple menu in chapter 5.

Main menu - allows you to access all the functionality of the controller (monitoring, adjustments and service settings.) Access to the main menu is done by pressing the button "Confirm, enter" on the main screen. Description of the main menu in Chapter 6

Back to the main screen is possible from any screen by pressing the button "Back, esc" several times.



WARNING !!! Access the service is intended only for qualified technical personnel. The changes may cause malfunction of the system.

4.2 Starting regulator - ON

To run the controller (ON mode) for 3 seconds to press the „ON / OFF“ on the screen when it is in the OFF mode.

4.3 Switching off the regulator - OFF

To turn off the controller (OFF mode) for 3 seconds to press the „ON / OFF“ on the screen when he is in the ON mode.



WARNING !!! When you turn off the controller, depending on the previous state, the burner can still work (quenching), the state should not be interrupted. If the device is to be excluded from the power supply, wait quenching process, until the status of the burner is "off".

4.4 Time scheduling

Controller is equipped with a clock and calendar. This makes it possible to program the operation of individual circuit elements for heating depending on the time and day of week. Date and time are not reset during a power failure, because the controller is equipped with a battery that should be replaced every two years.

Programming takes place in the menu of the circuit (eg, hot water, heating, buffer) and for each item carried in the same way.

Selecting the day of week. Upon entry in the "Programme Time" day of the week flashes. Arrow buttons to select the day you want to set or just check the settings of the program.

Programming. After selecting the day of week and approved "ENTER", indicator being programmed hours flashes. At the same time also displays the time, and the next to it icon that represents the currently selected setting time (the symbol of the sun means comfort temperature, the moon is a symbol of the economic temperature.) To move to the next hour, press the down arrow (economy temperature) or the up arrow (comfort temperature). If the day is already programmed in accordance with our wish, press "ENTER". After approved the changes (or cancellation) will blink day of the week.

The figure shows an example of the preset day of the week.

- Temp. economy from 00:00 to 6:00
- Temp. comfortable from 6:00 to 9:00
- Temp. economy from 9:00 to 18:00
- Temp. comfortable from 18:00 to 24:00

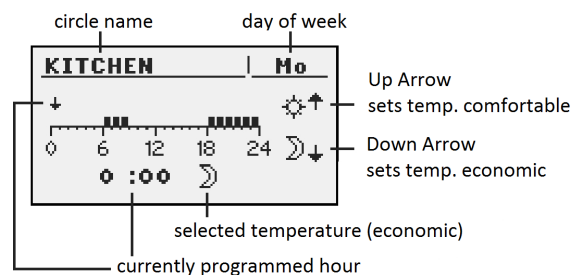

WARNING !!! Values of temperatures comfortable and economical are set in the "SETTINGS" menu and may be different for each of the circuits. To make the time program work, you must also enable a timed mode in the "SETTINGS" menu.

4 Handling

4.5 Service password

Access to the service parameters are password protected. After entering the correct password, access will be lifted. Access to the service parameters will be locked after a period of 10 minutes without pushing buttons.

Service code is a temperature of the boiler in menu BOILER / SETTINGS and 3 letters "EST".

Example: If the temperature of the boiler in menu BOILER / SETTINGS is 60 ° C, password is "60EST".



WARNING !!! Access the service is intended only for qualified technical personnel. The changes may cause malfunction of the system.



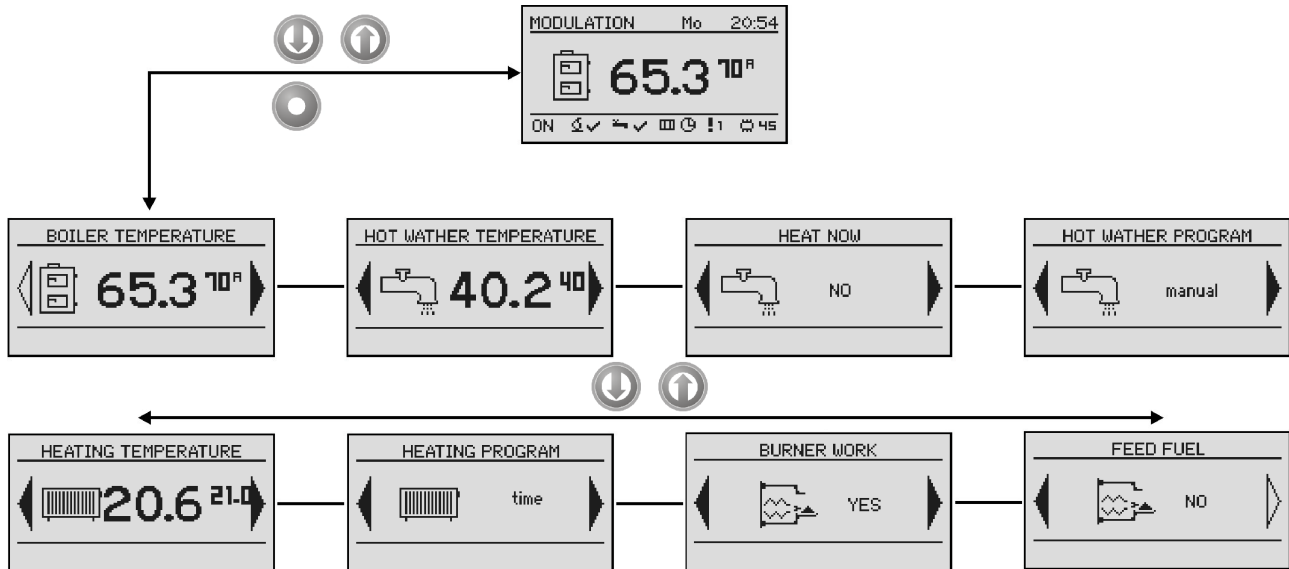

5 Simple menu

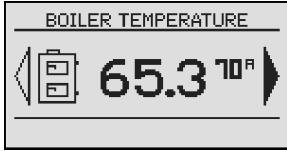
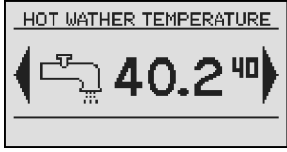
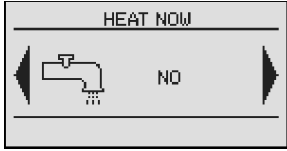

5.1 Simple menu screens

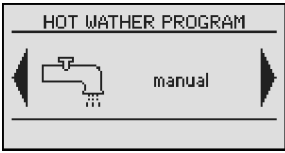
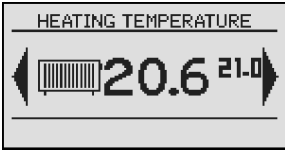
Screen	Description
	Shows the current temperature of the boiler (large font) and the desired temperature (small font). After pressing the "ENTER" set the desired temperature of the boiler.
	Shows the current temperature of hot water (large font) and the desired temperature (small font). After pressing the "ENTER" set the desired temperature of hot water. <i>Menu relates to the circuit No. 1</i>
	Disposable heating hot water to a comfortable temperature regardless of the program. <i>Menu relates to the circuit No. 1</i>

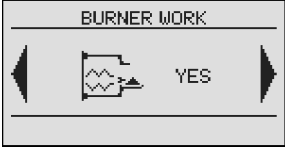
5 Simple menu

	<p>Set the mode a hot water:</p> <ul style="list-style-type: none"> a) time - according to the programmed timescales b) constant - regardless of the time intervals comfortable temperature is maintained c) disabled - off the heat <p><i>Menu relates to the circuit No. 1</i></p>
	<p>Shows the current temperature in the room No 1 (large font) and the value of the desired (small font). After pressing the "ENTER", go to set the desired temperature in the room.</p> <p><i>Menu relates to the circuit No. 1</i></p>
	<p>Set the mode a heating circuit:</p> <ul style="list-style-type: none"> a) time - according to preset ranges b) constant - regardless of the time intervals comfortable temperature is maintained c) disabled - off the heat <p><i>Menu relates to the circuit No. 1</i></p>
	<p>Allow for operation of the burner. When not consent to the burner operation, regulator controls the heating system, but do not attach the burner.</p>
	<p>Manual start of the fuel feed from the tray. Useful function after the exhaustion of fuel from the cartridge. After refilling the fuel cartridge, run the "enter fuel" until the fuel gets into the burner.</p>

6 Main menu

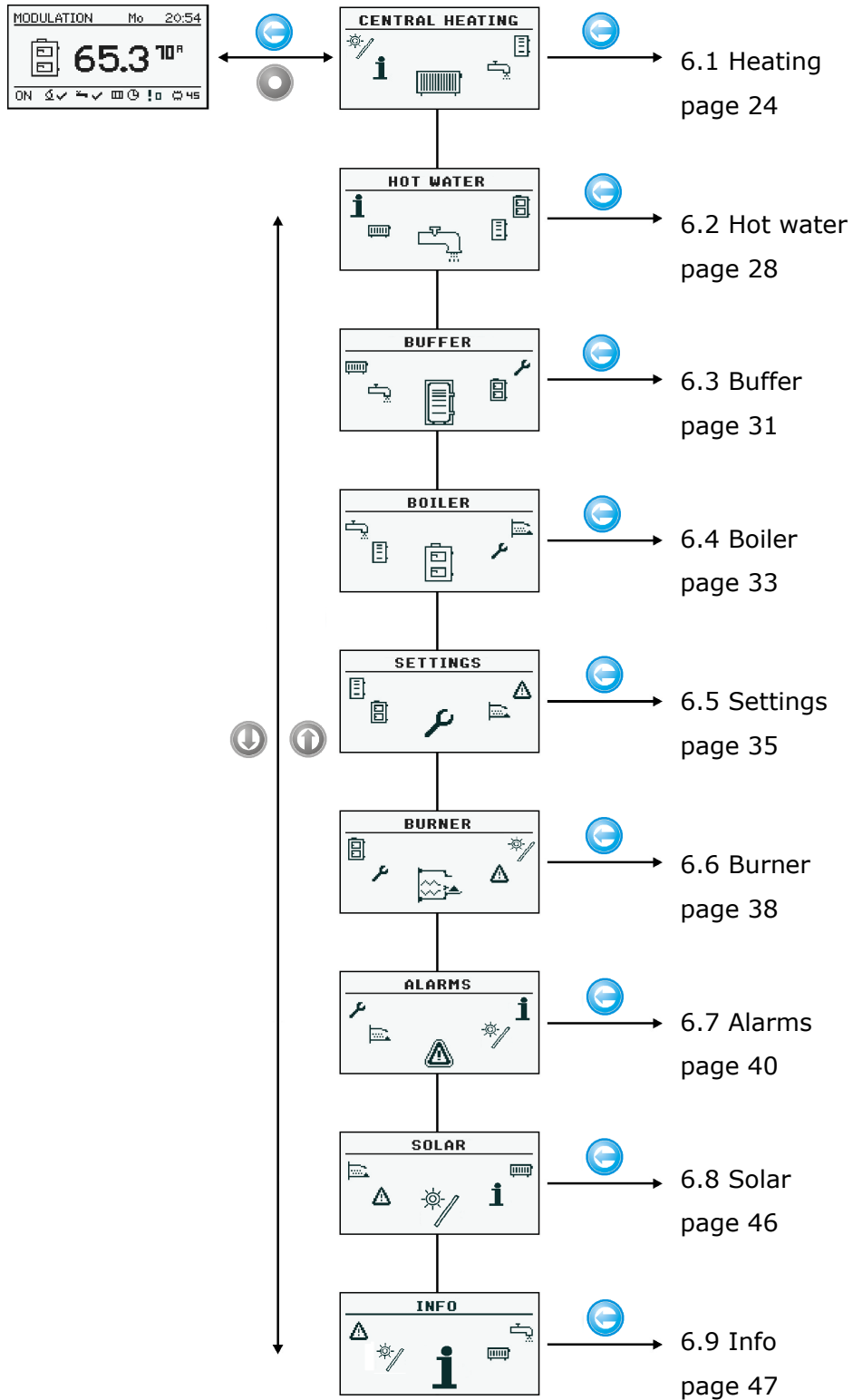

6 Main menu

6.1 Heating

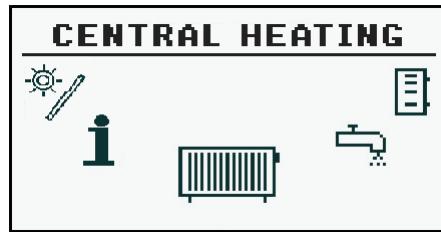

6.1.1 Selection of circuit

Allows you to select a number of central heating circuit. The selection of the circuit make arrows.



6.1.2 State

Allows you to monitor the status of central heating system.

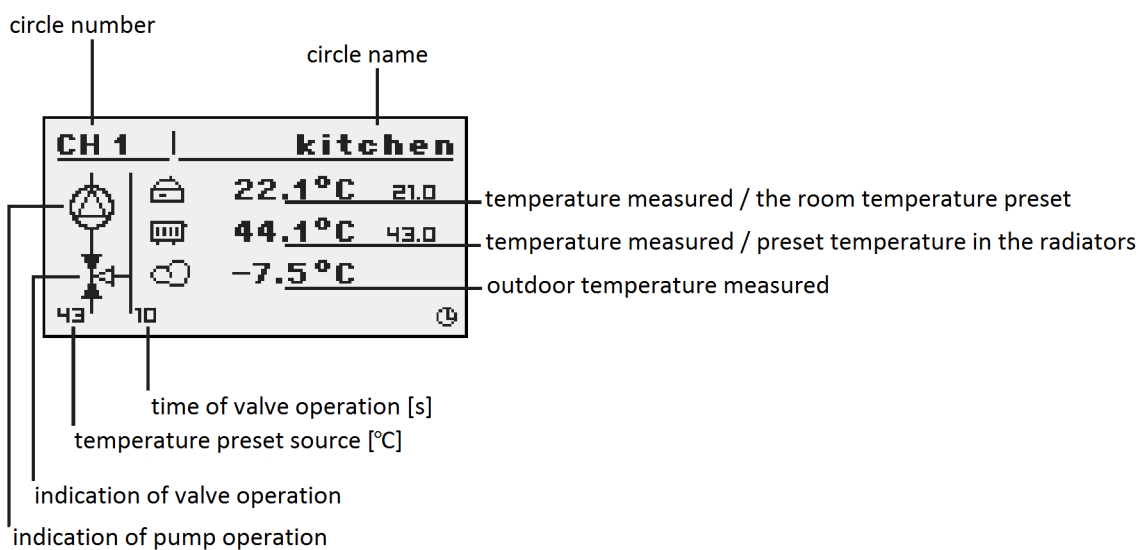

6.1.3 Settings

Settings	
Function	Description
Comfortable temp.	Desired temperature in the room during the heating.
Programme	Programs: a) time - according to preset intervals b) constant - regardless of the time intervals comfortable temperature is maintained c) disabled - off the heat d) economic - in the rooms temperature is maintained the economic
Economical temp.	Desired temperature in the room outside the period of heating.

6.1.4 Time program

Used to configure the time program steering central heating.

Description of the adjustment time program refer to chapter 4.4.

6 Main menu

6.1.5 Service



WARNING !!! Access the service is intended only for qualified technical personnel. The changes may cause malfunction of the system.

Service	
Function	Description
Comf. MAX pump temp.	Maximum outdoor temperature at which the circulating pump can work in a comfortable range.
Econ. MAX pump temp.	Maximum outdoor temperature at which the circulating pump can work in a economic range.
MIN Tch pump	Minimum temperature calculated for central heating at which the circulating pump can be operated.
Source	Specifies the source of energy for central heating circuit.
Temperature MAX	Maximum temperature for central heating.
Mixer time	Time of full opening of the mixer.
Hot water priority	Priority for hot water of the heating circuit. During heating hot water the central heating pump is not working.
Pump test	Starts the pump regardless of other conditions.
Mixer test	Starts the mixer motor independently of the other conditions.
Circ. name	Gives name for the central heating circuit.
CH temp. for -20°C	The point of the heating curve for -20 ° C.
CH temp. for 0°C	The point of the heating curve for 0 ° C.
CH temp. for 10°C	The point of the heating curve at 10 ° C.

6 Main menu

Service	
CH temp. for corr. factor	Central heating temperature correction required the desired room temperature for 1 ° C. For example, if the correction factor is set at 6 ° C, room temperature set at 20 ° C and measured in the room is 20.5 ° C then the temperature calculated at will be reduced by 3 ° C.
Mode type	Specifies the input mode central heating temperature: manual - the temperature of central heating inflicted manually, weather - the temperature of central heating calculated from the heating curve.
Manual Tch	The desired temperature of central heating when the mode is set to manual.
Room temp. sensor	Specifies whether the system uses a room sensor.
CH temp. sensor	Specifies whether the system uses a sensor heating.
Permanent pump	Yes - the pump runs at a given temperature in the room, reduced the temperature for heating (only with the use of a sensor for central heating and room sensor), No - after reaching the set temperature in the room the pump is turned off.

6 Main menu

6.2 Hot water

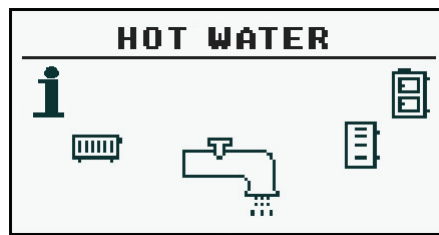

6.2.1 Selection of circuit

Allows you to select the number of hot water circuit.

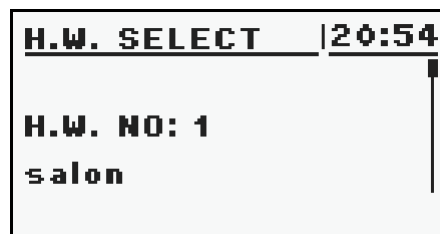

6.2.2 State

Allows you to monitor the status of hot water.

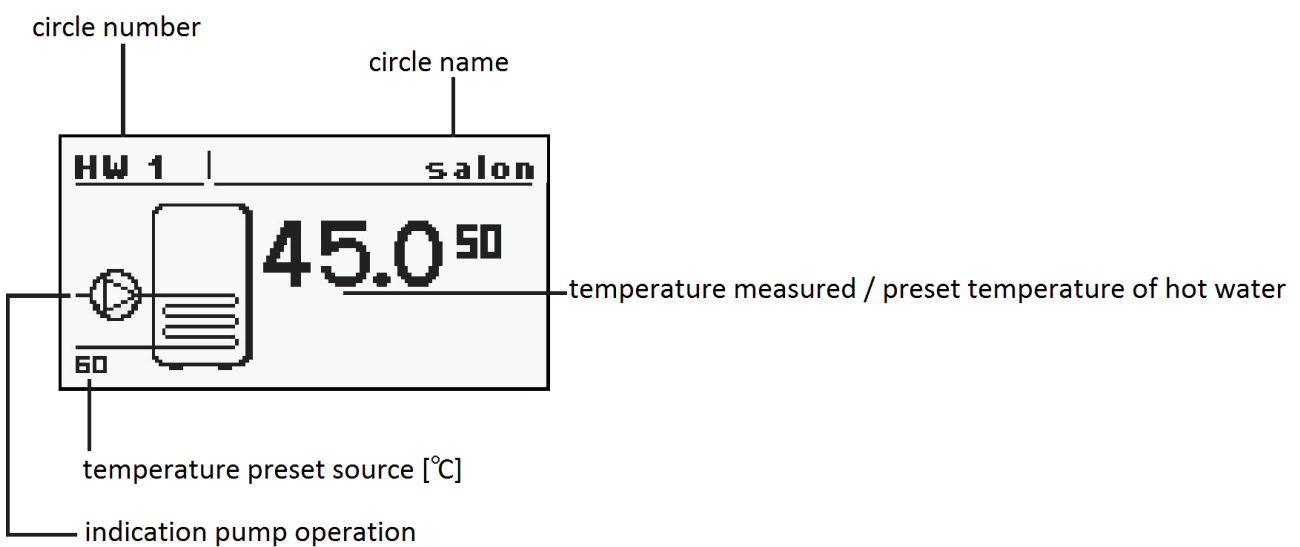

6.2.3 Settings

Settings	
Function	Description
Comfortable temp.	Desired temperature of hot water during heating.
Programme	Set the mode a circuit: a) time - according to preset ranges b) constant - regardless of the time intervals comfortable temperature is maintained c) disabled - off the heat.
Heat now	Heats hot water once to a comfortable temperature regardless of the program.
Hysteresis	The value of which can reduce the temperature of hot water.
Economical temp.	Desired temperature of hot water outside the period of heating.

6.2.4 Time program

Used to configure the time steering hot water preparation.

Description of the adjustment time refer to chapter 4.4.

6 Main menu

6.2.5 Service



WARNING !!! Access the service is intended only for qualified technical personnel. The changes may cause malfunction of the system.

Service	
Function	Description
Source delta	Increasing the temperature of the source of the desired temperature of hot water during heating.
Source	Specifies the source of energy for hot water.
Temperature MAX	Maximum temperature of hot water.
Delta MIN temp.	The minimum temperature difference between the source and the hot water at which the pump can work.
Pump test	Starts the pump regardless of other conditions.
Circ. name	Gives name for the hot water circuit.

6.3 Buffer



6.3.1 State

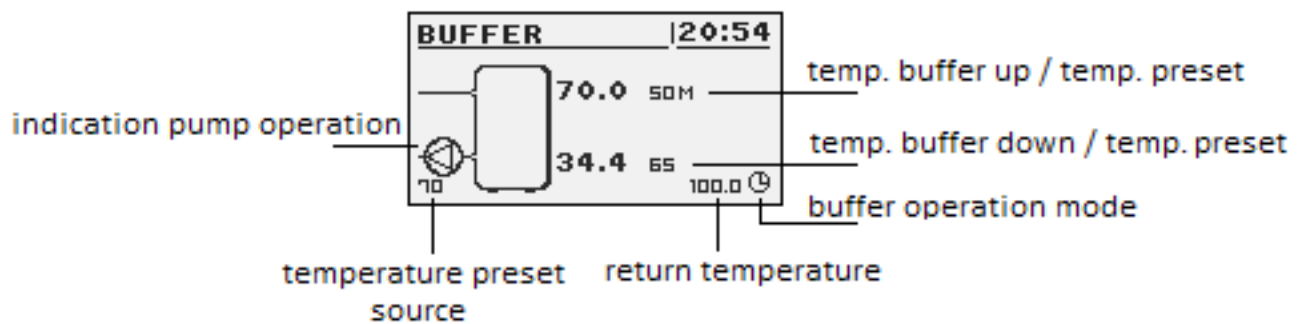

6.3.2 Settings

Settings	
Function	Description
Upper set temperature	Below this temperature in the upper part of the buffer starts charging.
Lower set temperature	Above this temperature at the bottom of a buffer completes the process of charging.
Programme	Constant - the buffer is charged regardless of the time, time - the buffer charged only at specified intervals. Intervals are set in the "time program", disabled - off charging buffer.

6 Main menu

6.3.3 Time program

Used to configure time program to controlling charging buffer.

Description of program adjustment time refer to chapter 4.4.

6.3.4 Service



WARNING !!! Access the service is intended only for qualified technical personnel. The changes may cause malfunction of the system.

Service	
Function	Description
Minimal pump temp.	The minimum temperature in the upper part of the buffer at which the circulating pump can work for central heating.
Auto upper temp.	Specifies whether the upper temperature buffer (minimum) is requested manually or automatically. Automatically based on the needs of other power consumers in the buffer.

6.4 Boiler

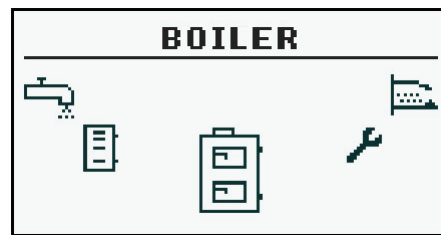

6.4.1 State

Statistics of the boiler in the past 24 hours. The graph shows the temperature of the boiler and power of burner. "Hours" refers to how many hours ago the boiler behaved these operating parameters. Across the screen are displayed statistics of 2 hours. Screens switching buttons "up" and "down".

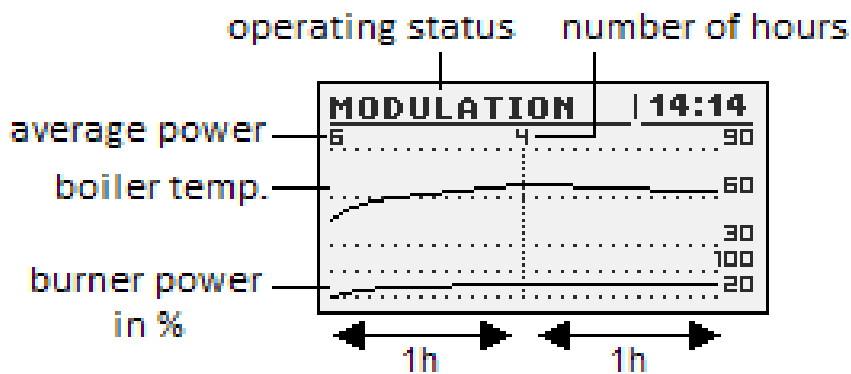

6.4.2 Settings

Settings	
Function	Description
Boiler temp. set	Heating water temperature in the boiler which will be maintain the controller. Menu is active only in continuous work mode.

6 Main menu

6.4.3 Service



WARNING !!! Access the service is intended only for qualified technical personnel. The changes may cause malfunction of the system.

Service	
Function	Description
MIN pump temp.	The temperature above which the the controller can attach pumps.
Mode	Operating mode of boiler: a) auto - temperature calculated automatically b) continuous - the temperature is kept constant
Hysteresis	The temperature of the boiler must be reduced by this value to launch the burner.
MIN return temp.	Minimal return to boiler temperature maintain by mixer.
Return mixer time	Specifies the time of full opening of the return mixer.
Boiler pump test	Starts boiler pump regardless of other conditions.
Return mixer test	Starts actuator of the return mixer regardless of other conditions.

6.5 Settings



6.5.1 Date and time

Using this menu is made to set the date and time of the driver.

6.5.2 Language

Use this menu to select language of the menu.

6.5.3 General settings

6.5.3.1 Alarm buzzer

We define here, if the driver shall notify of alarms by acoustic signal.

6.5.4 Service



WARNING !!! Access the service is intended only for qualified technical personnel. The changes may cause malfunction of the system.

6 Main menu

6.5.4.1 Module configuration

Menu is used to configure the CAN network. In the menu, select the modules that are connected to the system.



WARNING !!! A detailed description of the modules and their destination are described in the manual of expansion modules.

SUMMARY OF THE EXPANSION MODULES	
Module	Description
Module no. 0	3 heating circuits of the numbers 2,3,4. Outdoor temperature sensor.
Module no. 1	3 heating circuits of the numbers 5,6,7.
Module no. 2	3 heating circuits of the numbers 8,9,10.
Module no. 3	3 heating circuits of the numbers 11,12,13.
Module no. 4	3 heating circuits of the numbers 14,15,16.
Module no. 5	Buffer. Solar collectors. Hot water no. 2. Return temperature sensor.
Module no. 6	Not used.
Module no. 7	Not used.
Module Lambda	Module of the Lambda sensor.

6.5.4.2 System configuration

Menu is used to configure the heating system (hydraulic). The possibility of settings is dependent of number of expansion modules connected in the system.



WARNING !!! You must first configure the modules.

SYSTEM CONFIGURATION	
Function	Description
Number of CH circuits	Specifies the number of heating circuits in the system.
Number of HW circuits	Specifies the number of hot water circuits in the system.
Number of buffers	Specifies the number of buffers in the system.
Outside temp. sensor	Specifies if in the system is installed outside temperature sensor (module 0).
Return temp. sensor	Specifies if in the system is installed return temperature sensor (module 5).
Solars	Specifies if the system is equipped with solar collectors.

6.5.4.3 Restore to factory settings

This function allows the controller to restore the factory settings.



WARNING !!! Will be restored all factory settings, which can cause your system to malfunction. After restoring the factory settings may be need to reconfigure the controller settings.

6 Main menu

6.6 Burner



6.6.1 State

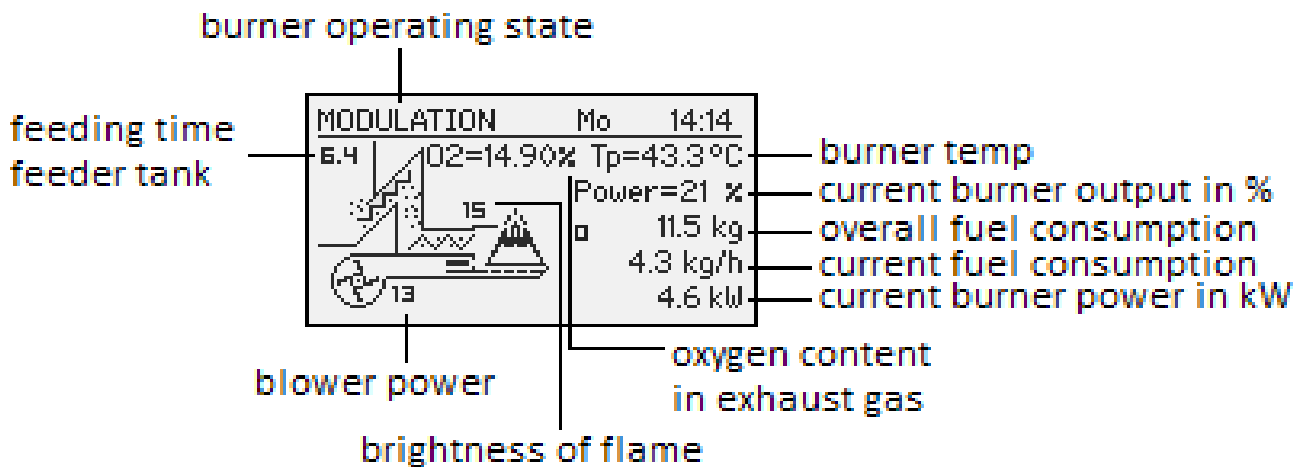

6.6.2 Settings

Settings	
Function	Description
Feed fuel now	Starts fuel feeding screw regardless of other features.
Burner on	Consent to work of the burner.
Fuel type	Specifies the type of fuel.

6.6.3 Service



WARNING !!! Access the service is intended only for qualified technical personnel. The changes may cause malfunction of the system.

Service	
Function	Description
Air MIN (20%)	Minimum amount of air during modulation where power of burner is 20% or power number is 1.
Air MAX (100%)	Maximum amount of air during modulation where power of burner is 100% or power number is 2.
Feeding MAX (100%)	Maximum time during fuel feeding when power of modulation is 100% or power number is 2 on every 20 seconds.
Power MIN (FL2)	Minimal burner power during modulation.
Power MAX (FL2)	Maximal burner power during modulation.
Modulation type	Burner mode, power modulation or two power levels.
Photo threshold	Brightness in the the burner over which is recognized as a fire.
Igniter test*	Turn on igniter for testing.
Heater feeder test*	Turn on burner feeder for testing.
Storage feeder test*	Turn on storage feeder for testing.
Blower test*	Turn on blower for testing.
Test fuel mass	Fuel mass obtained during continuous fuel feeder work through 1 hour (in kg).
Fuel calorific value	Fuel calorific value (in kWh/kg).
Lambda control	Determine whether regulator consider or not oxygen concentration.
Oxygen MIN (20%)	Oxygen target for minimal power.
Oxygen MAX (100%)	Oxygen target for maximal power.

* testing equipment in the menu "BURNER" is only possible when the controller is in the OFF mode.

6 Main menu

6.7 Alarms



This menu contains a history of up to 20 alarms that occurred during the controller work. The importance of alarm codes was presented in table below.

6.7.1 Alarm codes

ALARM CODES AND THEIR SIGNIFICANCE		
CODE	Short description	Explanation
1	Processor overheating	Processor overheating. The reason may be improper installation location of the controller.
2	No fire / fuel	The controller detected a lack of flame in the burner. The reason could be the end of the fuel or the flame goes out.
3	Burner overheating	The temperature of the burner has reached its maximum value!
4	Boiler sensor shorted	The controller detected shorted boiler temperature sensor. The reason may be damaged sensor or connection cable.
5	Boiler sensor open	The controller detected open boiler temperature sensor. The reason may be damaged sensor or connection cable.
6	Burner sensor shorted	The controller detected shorted burner temperature sensor. The reason may be damaged sensor or connection cable.
7	Burner sensor open	The controller detected open burner temperature sensor. The reason may be damaged sensor or connection cable.

6 Main menu

8	Boiler overheating	Boiler temperature has exceeded the maximum value!
9	Processor reset	Probable damage the controller! Possible to loss of power supply.
10	STB	
11	Communication with module 0	
12	Communication with module 1	
13	Communication with module 2	
14	Communication with module 3	
15	Communication with module 4	
16	Communication with module 5	
17	Communication with module 6	
18	Communication with module 7	
19	HW sensor shorted	
20	HW sensor open	
21	Room temp. sensor shorted	
22	Room temp. sensor open	
23	Quenching error	
24	Lambda communication	
25	Solars overheating	
26	Solars freezing	
The codes of the modules		
33	Shorted IN1 Module 0	
34	Shorted IN2 Module 0	
35	Shorted IN3 Module 0	
36	Shorted IN4 Module 0	
37	Shorted IN5 Module 0	
38	Shorted IN6 Module 0	

6 Main menu

39	--	
40	--	
41	--	
42	--	
43	Shorted IN11 Module 0	
44	--	
45	Open IN1 Module 0	
46	Open IN2 Module 0	
47	Open IN3 Module 0	
48	Open IN4 Module 0	
49	Open IN5 Module 0	
50	Open IN6 Module 0	
51	--	
52	--	
53	--	
54	--	
55	Open IN11 Module 0	
56	--	
57	--	
58	Overheating Module 0	
65	Shorted IN1 Module 1	
66	Shorted IN2 Module 1	
67	Shorted IN3 Module 1	
68	Shorted IN4 Module 1	
69	Shorted IN5 Module 1	
70	Shorted IN6 Module 1	
71	--	
72	--	
73	--	
74	--	
75	--	
76	--	
77	Open IN1 Module 1	
78	Open IN2 Module 1	
79	Open IN3 Module 1	

6 Main menu

80	Open IN4 Module 1	
81	Open IN5 Module 1	
82	Open IN6 Module 1	
83	--	
84	--	
85	--	
86	--	
87	--	
88	--	
89	--	
90	Overheating Module 1	
97	Shorted IN1 Module 2	
98	Shorted IN2 Module 2	
99	Shorted IN3 Module 2	
100	Shorted IN4 Module 2	
101	Shorted IN5 Module 2	
102	Shorted IN6 Module 2	
103	--	
104	--	
105	--	
106	--	
107	--	
108	--	
109	Open IN1 Module 2	
110	Open IN2 Module 2	
111	Open IN3 Module 2	
112	Open IN4 Module 2	
113	Open IN5 Module 2	
114	Open IN6 Module 2	
115	--	
116	--	
117	--	
118	--	
119	--	
120	--	

6 Main menu

121	--	
122	Overheating Module 2	
129	Shorted IN1 Module 3	
130	Shorted IN2 Module 3	
131	Shorted IN3 Module 3	
132	Shorted IN4 Module 3	
133	Shorted IN5 Module 3	
134	Shorted IN6 Module 3	
135	--	
136	--	
137	--	
138	--	
139	--	
140	--	
141	Open IN1 Module 3	
142	Open IN2 Module 3	
143	Open IN3 Module 3	
144	Open IN4 Module 3	
145	Open IN5 Module 3	
146	Open IN6 Module 3	
147	--	
148	--	
149	--	
150	--	
151	--	
152	--	
153	--	
154	Overheating Module 3	
161	Shorted IN1 Module 4	
162	Shorted IN2 Module 4	
163	Shorted IN3 Module 4	
164	Shorted IN4 Module 4	
165	Shorted IN5 Module 4	
166	Shorted IN6 Module 4	

6 Main menu

167	--	
168	--	
169	--	
170	--	
171	--	
172	--	
173	Open IN1 Module 4	
174	Open IN2 Module 4	
175	Open IN3 Module 4	
176	Open IN4 Module 4	
177	Open IN5 Module 4	
178	Open IN6 Module 4	
179	--	
180	--	
181	--	
182	--	
183	--	
184	--	
185	--	
186	Overheating Module 4	
193	Shorted IN1 Module 5	
194	Shorted IN2 Module 5	
195	Shorted IN3 Module 5	
196	Shorted IN4 Module 5	
197	--	
198	Shorted IN6 Module 5	
199	Shorted IN7 Module 5	
200	Shorted IN8 Module 5	
201	Shorted IN9 Module 5	
202	--	
203	--	
204	--	
205	--	
206	Overheating Module 5	

6 Main menu

6.8 Solar

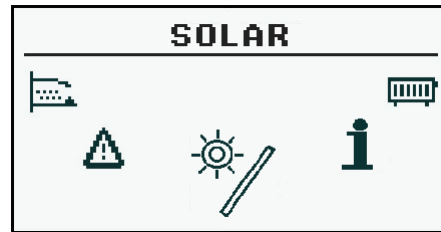

6.8.1 State

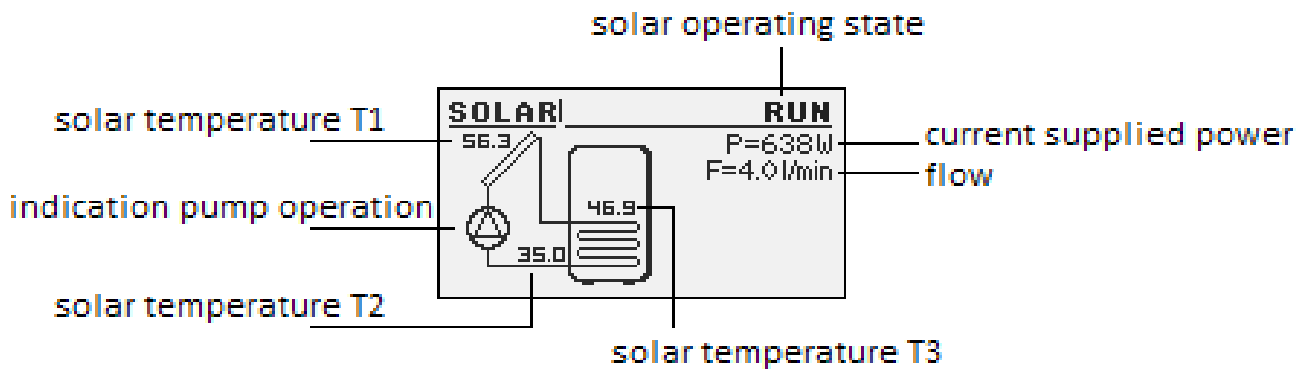

6.8.2 Settings

Settings	
Function	Description
Turn on delta	Temp. difference between solar and accumulator needed for solar pump turn on.
Turn off delta	Temp. difference between solar and accumulator needed for solar pump turn off.

6.8.3 Service

Service	
Function	Description
Schematic	Solar system schematic.
Flow [l/min]	Heating fluid flow in l/min.
Fluid specific heat	Specific heat of heat-transfer fluid [kJ/(kg*K)].
MAX HW temp.	Over this hot water temp. solar pump is turn off.
Solar alarm temp. MAX	Maximal temp. of solar collector. Alarm and damage preservation procedure are taken over this temp.
Solar alarm temp MIN	Minimal temp. of solar collector. Alarm and antifreeze procedure are taken under this temp.
Solar pump test	Allow for solar pump testing.

6.9 Info

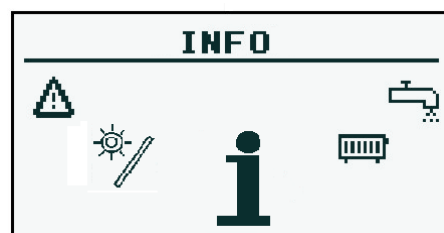

There you will find useful information about the controller, including the version of software.

7 Expansion of the system - CAN bus

7 Expansion of the system - CAN bus

The controller is equipped with a high bandwidth CAN bus used to communicate with the modules. Thanks to the well-known for their reliability, widely used in automotive bus system is expandable to the highest level.

Use of CAN bus carries several advantages. Gain above all the possibility of using broadband Lambda oxygen sensor and the using additional of expansion modules rozszerzeniowych I / O we can install throughout the system:

- to 16 are heating circuits,
- 2 circuits of hot water,
- heat storage tank (buffer),
- solar system (solars).

Socket CAN bus is on the left side of the device. Connecting cable must be connected according to the following designation.

Cable connection:

L – line LOW (white)

H – line HIGH (brown)

GND – ground (grey)

For connections on the CAN bus should be only used cable **LiYCY 2x0,25**.

Only this type of cable gives the proper work of devices. Connections perform in a serial manner, this represents a figure below.

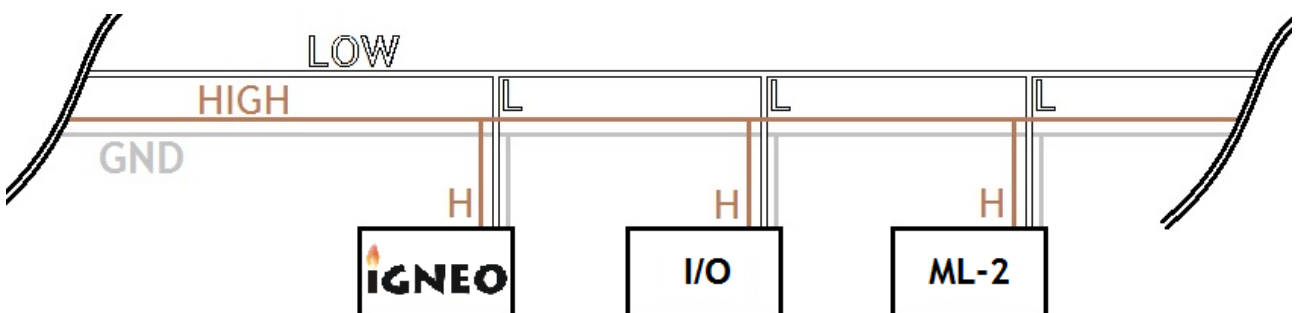

7 Expansion of the system - CAN bus

Plugging in expansion modules you need to remember to correctly set the terminator, which should be attached only at the last module throughout the system, even if the module is the only one.

After performing all the connections you must configure the module settings. Make this by selecting the modules that are connected to the network. More about the configuration each of expansion modules can be found in chapter 6.5.4.1 and instruction of the enlargement module I/O.

After finishing configuration of expansion modules to do remains only a change the system settings. Menu is used to configuration the heating system and the possibility of settings is dependent of number of arranged expansion modules. The table describing the functions refer to chapter 6.5.4.2.

On the next page is a sample diagram of the system. Please note that this is only overhead view, not containing all the elements of the system.

7 Expansion of the system - CAN bus

IMPORTANT!
Scheme does not include all elements of the system.

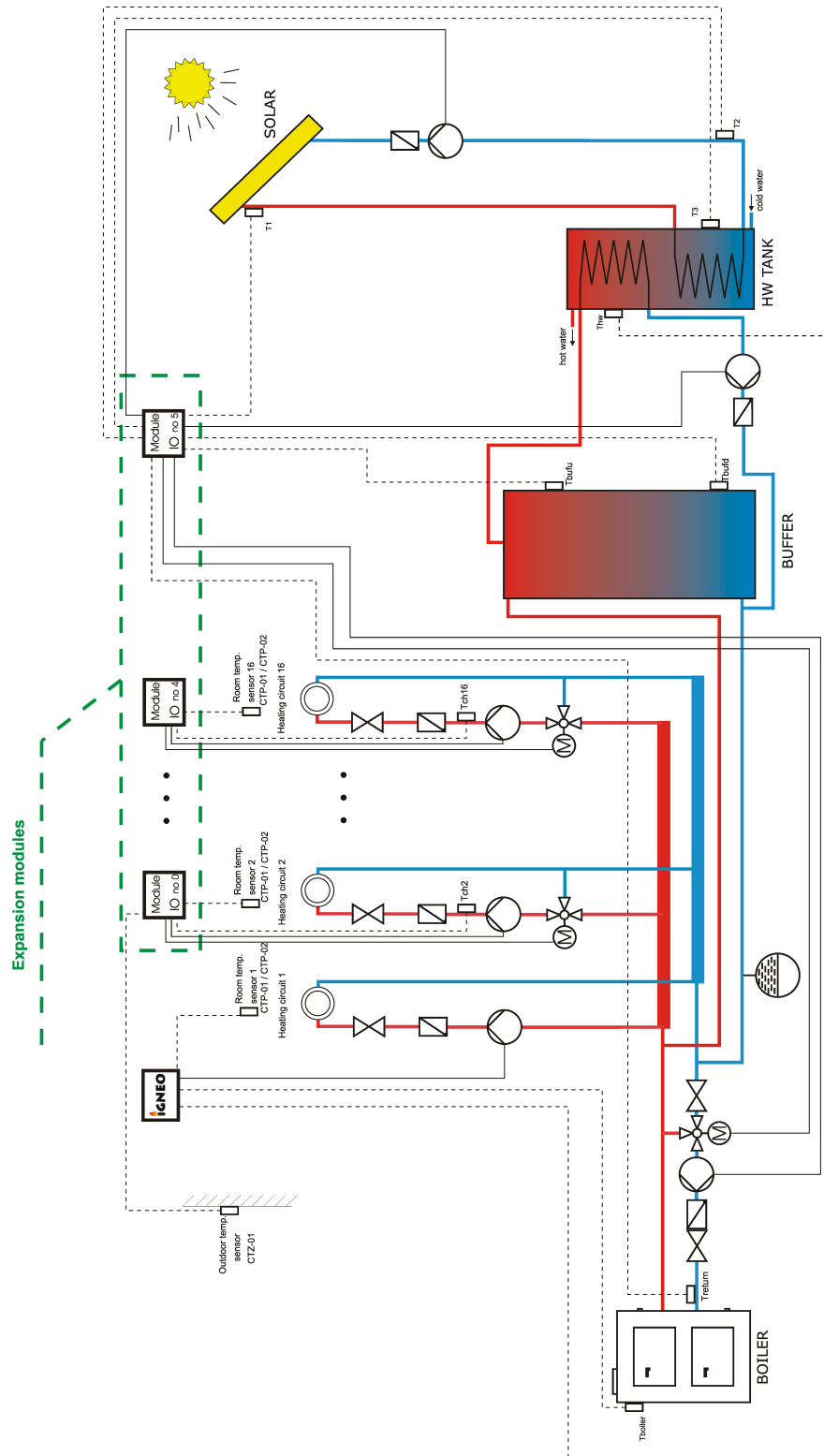

7 Expansion of the system - CAN bus

7.1 Sonda Lambda

Lambda sensor we can connect to the system in two ways:

- directly to the controller, if the entire system with CAN bus module will only use Lambda oxygen sensor,
- through enlargement module I/O with the number 5, if in the system there are other modules enlargement.

After connecting the module configure the controller yet. For this purpose, proceed as explained below.

From the main menu select **SETTINGS**



Then in the mode **SERVICE** enter the access code



After inputting the correct code, run the **MODULES CONFIGURATION**

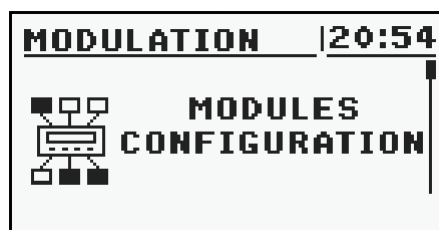

7 Expansion of the system - CAN bus

Find **Lambda Module** and turn it on by changing the option to **YES**

MODULATION	20:54
Module 6	NO
Module 7	NO
Module Lambda	YES

At this point, turned on the module Lambda. The second step is a change the configuration settings for the burner.

From the main menu by selecting **BURNER** we get to the settings

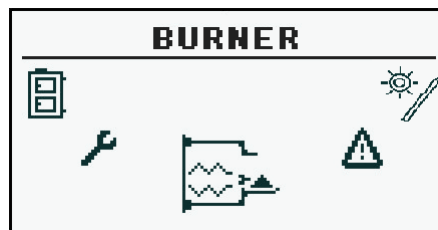

Here you can again enter the mode **SERVICE** and if required, enter the access code

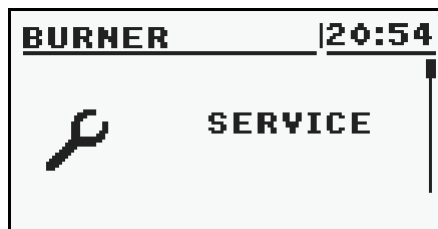

In the list, you can locate the position **Lambda control**, which switches on **YES**.

It is also possible working with switched off Lambda control mode. Then Lambda oxygen sensor module will be responsible only for displaying the measurements.

BURNER	20:54
Test fuel mass	0.0
Fuel calorific value	0.0
Lambda control	YES

7 Expansion of the system - CAN bus

7.2 Solars

Solar collectors are supported only by enlargement module I/O number 5th. After performing all the connections you must configure the controller to work with collectors proceed as described below. The first step is to enable module number 5.

From the main menu select **SETTINGS**



Then in the mode **SERVICE** enter the access code



After inputting the correct code, run the **MODULES CONFIGURATION**

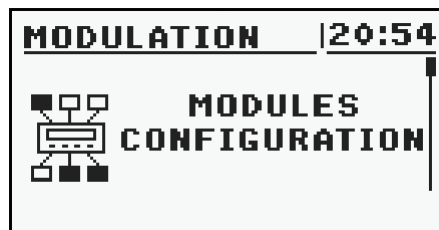

7 Expansion of the system - CAN bus

Find **Module 5** and activate it by changing the settings to **YES**

MODULATION	20:54
Module 4	NO
Module 5	YES
Module 6	NO

Now enable the solar handling.

As the main menu select **SETTINGS** and then enter the access code in the **SERVICE** mode



After entering the code run **SYSTEM CONFIGURATION**

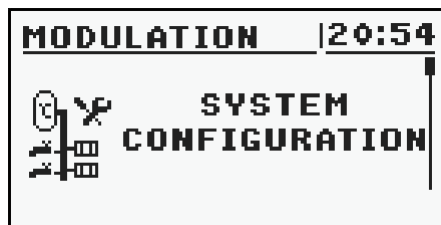

Find the position **Solars** and activate them by changing the settings to **YES**

MODULATION	20:54
Outside temp. sensor	NO
Return temp. sensor	NO
Solars	YES

After finishing configuration the controller we can start to change the adjustment and settings for Solars. Description of the configuration these elements can be found in chapter 6.8.

8 Specification

Technical data	
Module supply voltage	~230V/50Hz ±10%
Power input (module)	<6VA
Temperature measurement accuracy	±4°C
Sensors	NTC 10kΩ B _{25/85} =3877K±0,75% VISHAY BC components
Ambient temperature	0-60°C
Moisture	5-95% non-condensing
Software class	A
Module output load capacity	
CH pump	100W
HW pump	100W
Igniter	400W
Blower	150W
Burner feeder	150W
Feeder tank	150W

CE

Manufactured by:

Estyma electronics
al. Lipowa 4
11-500 Giżycko
POLAND

tel. +48 87 429 86 75
fax +48 87 429 86 75
biuro@estyma.pl

www.estyma.pl

